

Installation Precaution:

1. Before installation, carefully read the manual and operate according to the content of the manual;
2. Installed by qualified electricians;
3. To avoid the risk of electric shock, make sure to turn off the power before installation and maintenance;
4. Suitable for indoor installation and use (not suitable for damp environments);
5. The light source of this lamp is non-replaceable, and once it needs to be replaced (such as at the end of the lamp's lifespan), the entire lamp should be replaced;
6. Do not install the lighting fixtures on unstable or unstable ceilings to prevent them from falling;
7. Keep this manual properly for future use.

Attention:

1. **It is prohibited to touch fingers or other objects with the reflector's light outlet, otherwise it will affect the light output effect!**
2. **When moving lighting fixtures, be careful not to press the panel!**

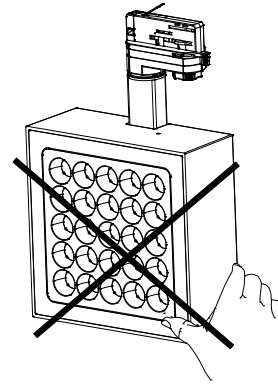
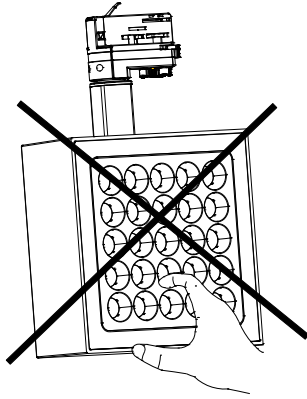

3. **If there is any protrusion or protrusion on the back cover of the lamp (as shown in the left figure below), press down with both hands and then release to reset the cover!**

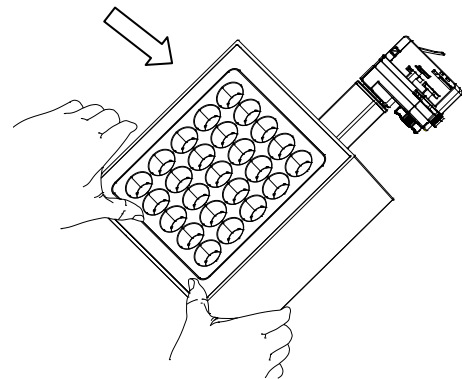
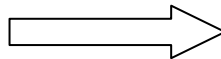
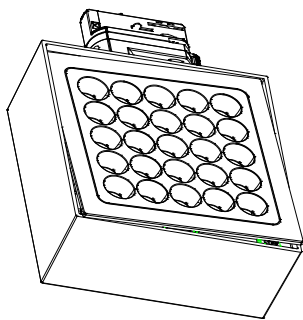

One.Assembly of track light connectors

1. Before assembly, ensure that the "conductive switch" is at a 90 ° angle with the connector and that the reversing knob is in the "OFF" state.

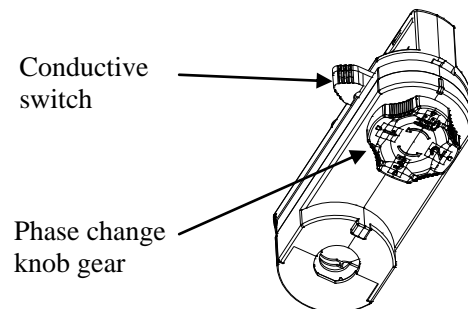
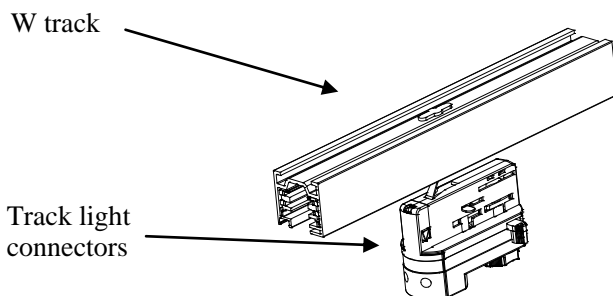

2. Align the protrusion of the track light connector with the groove of the track before assembly.

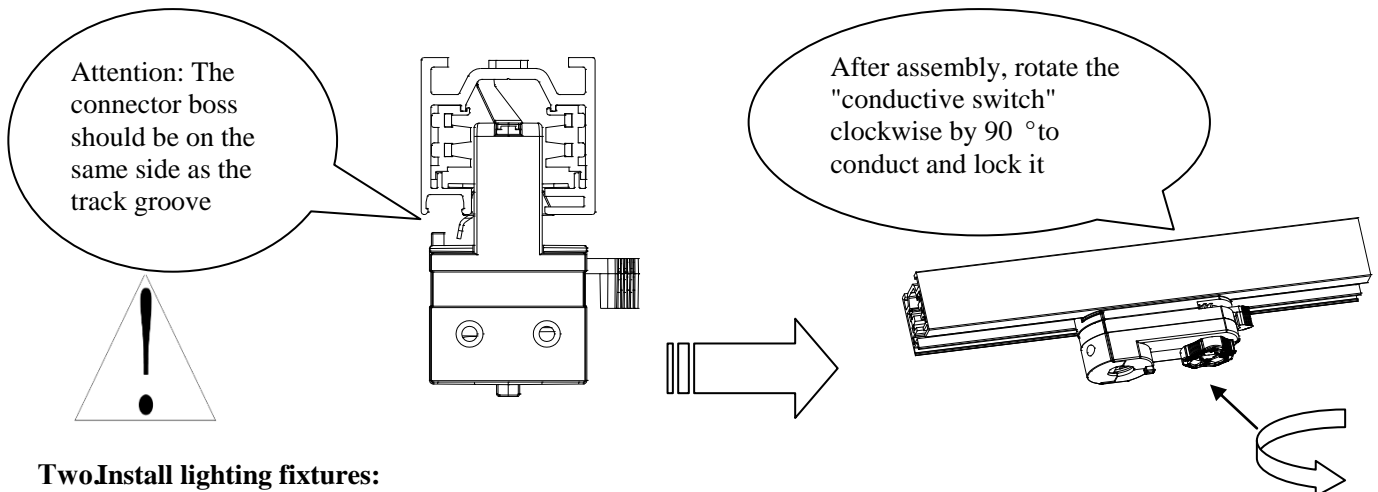

Two. Install lighting fixtures:

After installing the guide rail light connector, pull out the steel cable at the upper end of the light fixture and hang the hook on the track or other suitable place. The schematic diagram after installation is as follows.

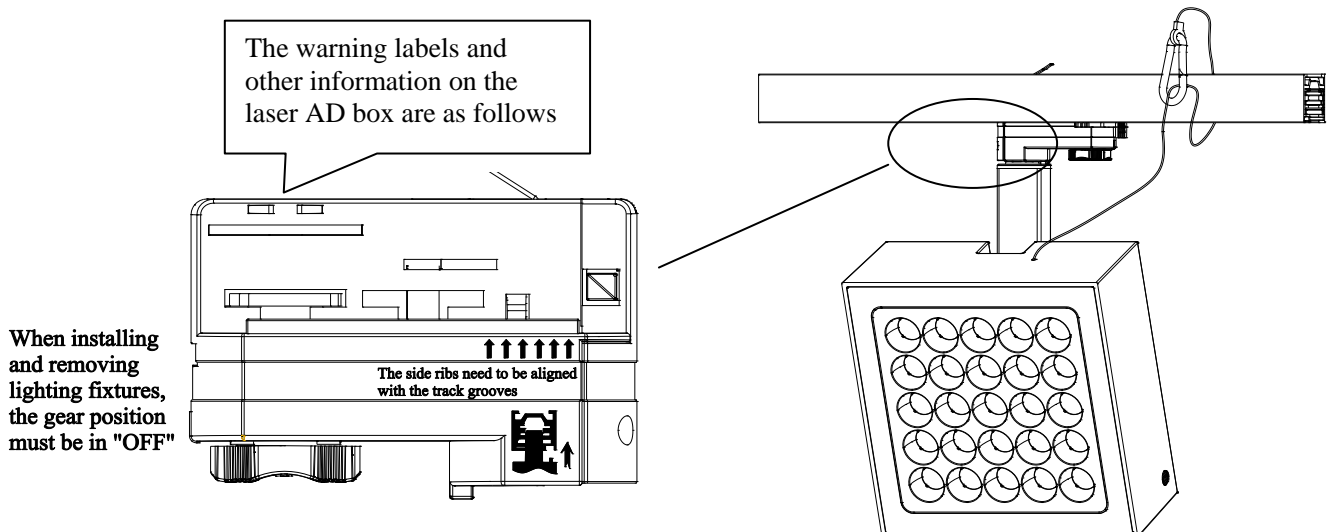

Three. Phase change adjustment and lamp removal:

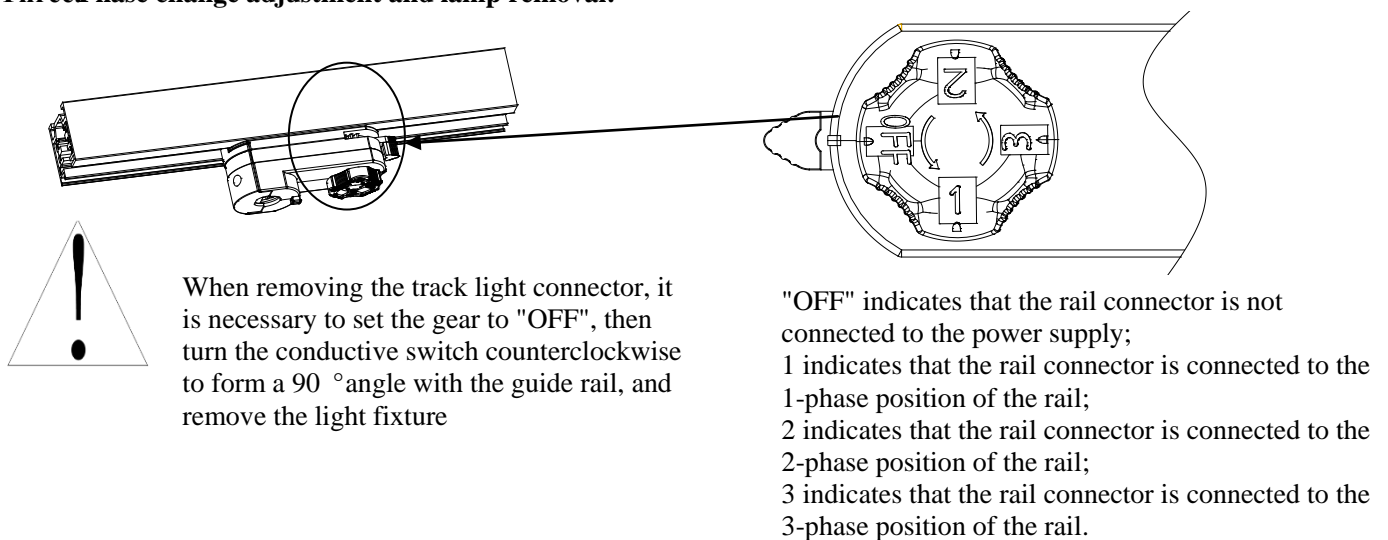

FOUR.Lamp adjustment:

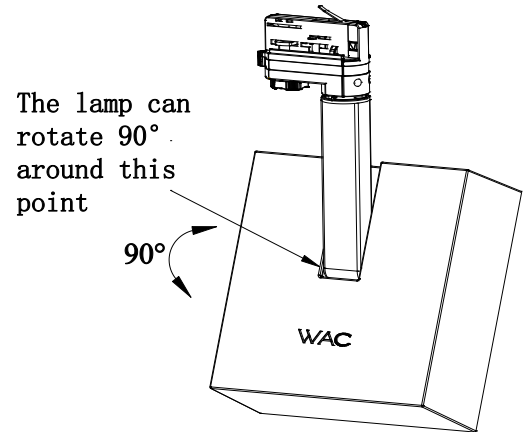
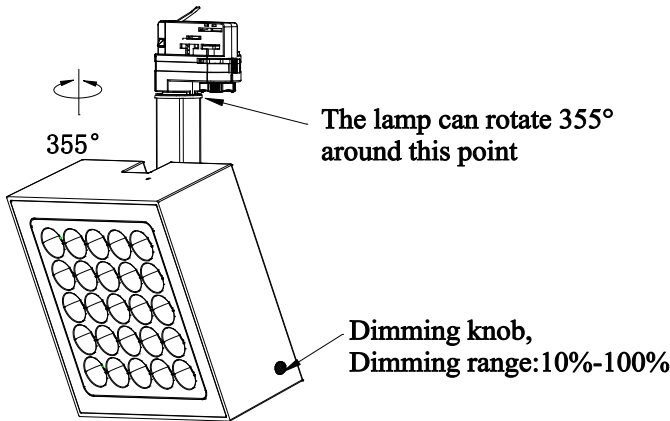

Five.Installation of attachments:

1. Replace optical accessories

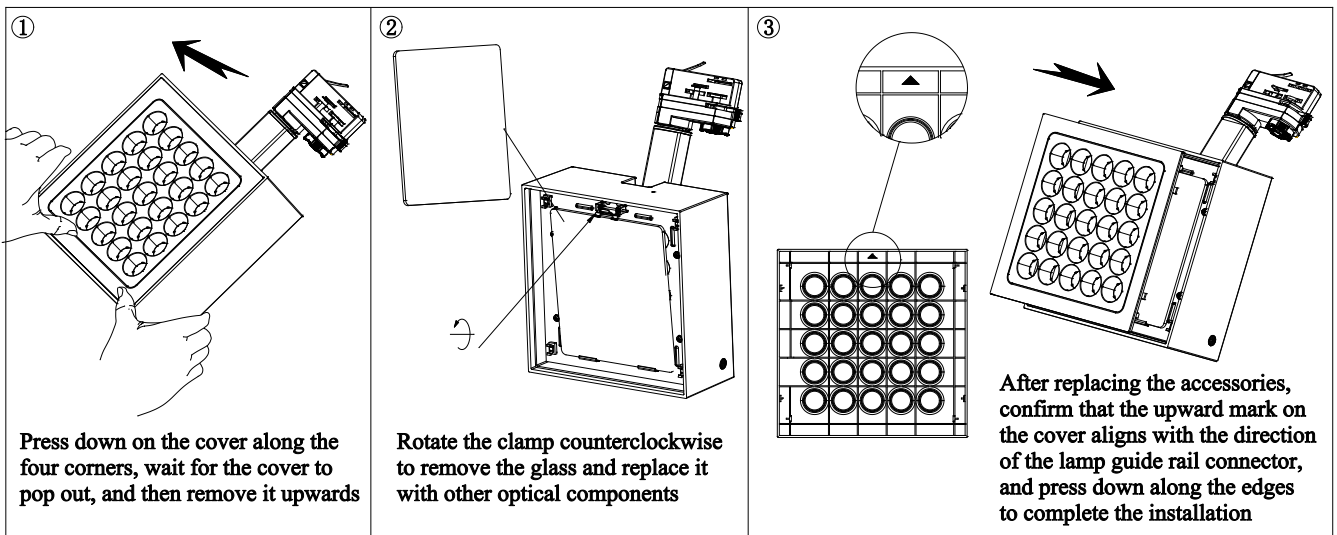

Six.Maximum lifting weight:

- The track system can withstand the maximum weight as shown in the following figure, which includes the weight of the entire suspension system.
- A single adapter can withstand a maximum load of 10kg (apply the load to the adapter according to the normal installation position of the lamp).

